

	9	10	11	12	13
H min	1890mm	2100mm	2310mm	2520mm	2730mm
H max	2079mm	2310mm	2541mm	2772mm	3003mm
DM120	268°	297°	326°	356°	385°
DM140	233°	258°	283°	308°	334°
DM160	207°	229°	251°	273°	295°

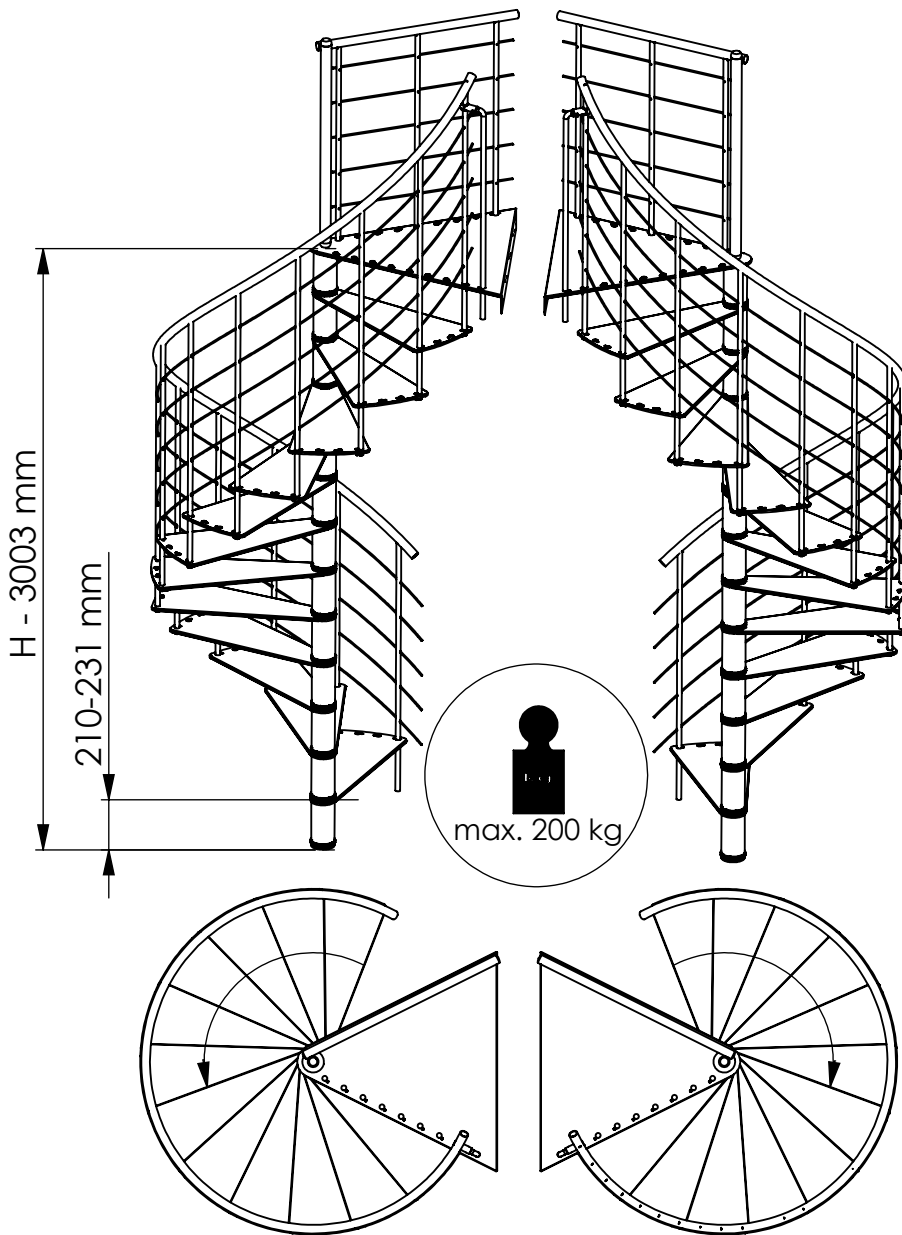

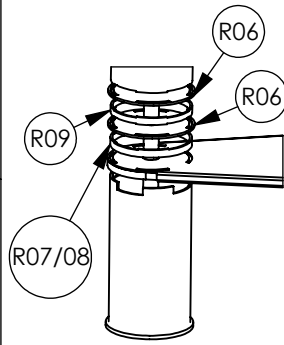

	R06	R07	R08	R09	h[mm]
h1	1x	0x	0x	0x	210
h2	1x	0x	1x	0x	215
h3	1x	1x	0x	0x	220
h4	2x	0x	1x	1x	226
h5	2x	1x	0x	1x	231

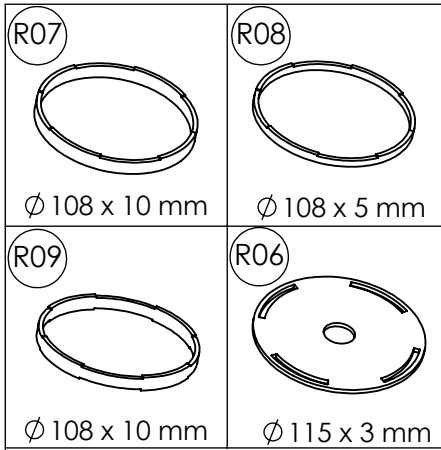
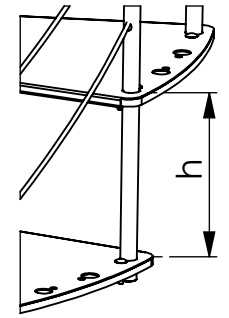

H [mm]	h1	h2
2730	13x	
2735	12x	1x
2740	11x	2x
2745	10x	3x
2750	9x	4x
2755	8x	5x
2760	7x	6x
2765	6x	7x
2770	5x	8x
2775	4x	9x
2780	3x	10x
2785	2x	11x
2790	1x	12x

H [mm]	h2	h3
2795	13x	
2800	12x	1x
2805	11x	2x
2810	10x	3x
2815	9x	4x
2820	8x	5x
2825	7x	6x
2830	6x	7x
2835	5x	8x
2840	4x	9x
2845	3x	10x
2850	2x	11x
2855	1x	12x

H [mm]	h3	h4
2860	13x	
2866	12x	1x
2872	11x	2x
2878	10x	3x
2884	9x	4x
2890	8x	5x
2896	7x	6x
2902	6x	7x
2908	5x	8x
2914	4x	9x
2920	3x	10x
2926	2x	11x
2932	1x	12x

H [mm]	h4	h5
2938	13x	
2943	12x	1x
2948	11x	2x
2953	10x	3x
2958	9x	4x
2963	8x	5x
2968	7x	6x
2973	6x	7x
2978	5x	8x
2983	4x	9x
2988	3x	10x
2993	2x	11x
2998	1x	12x
3003		13x

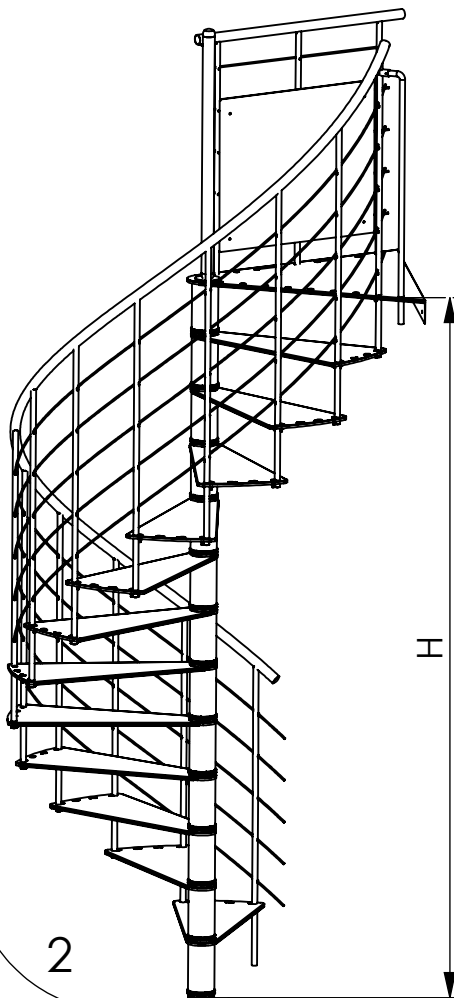

DM 120

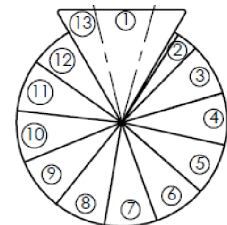
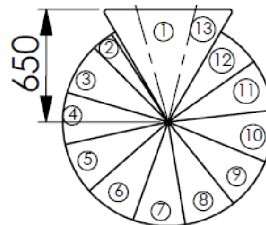

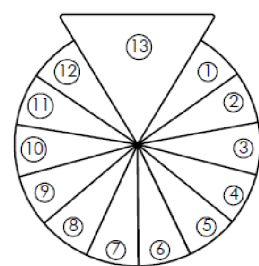
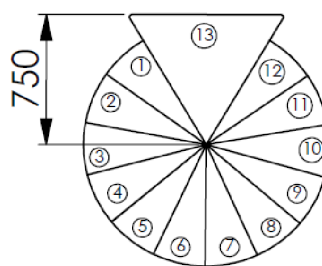

DM 140

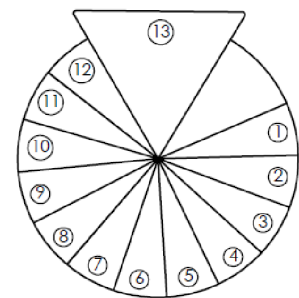
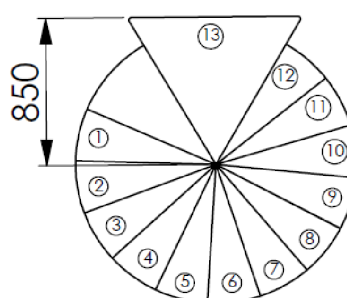

DM 160

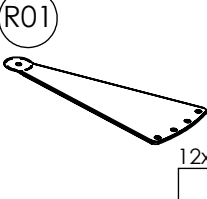
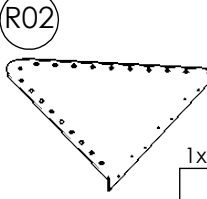
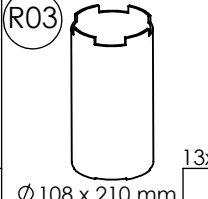
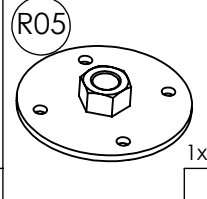
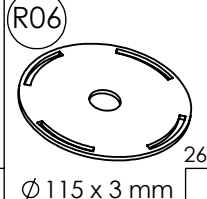
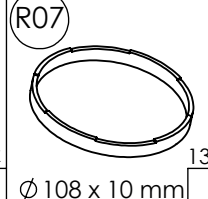
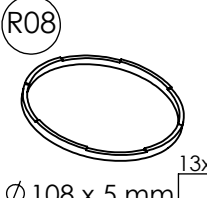
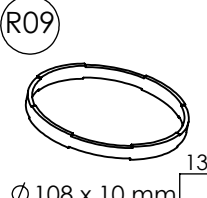
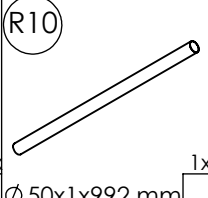
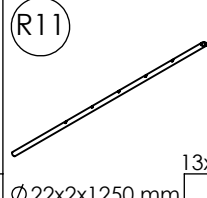
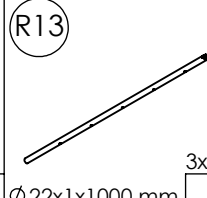
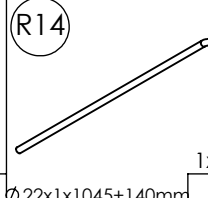
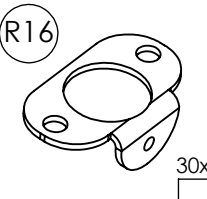
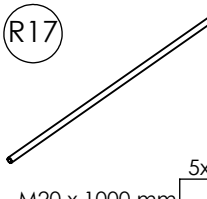
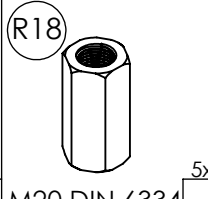
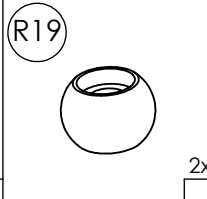

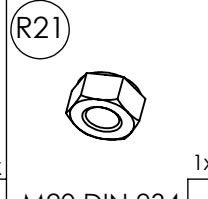
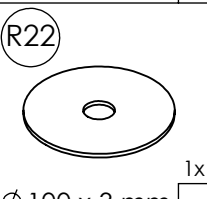
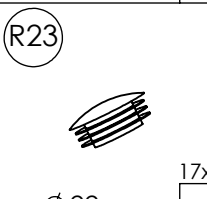
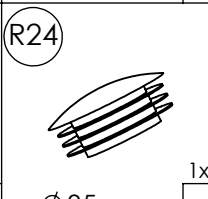
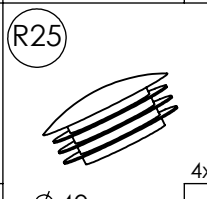
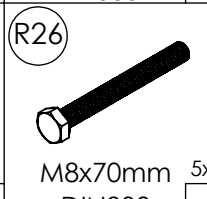
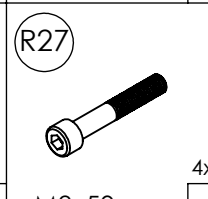
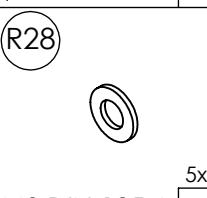
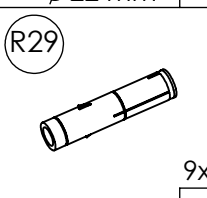
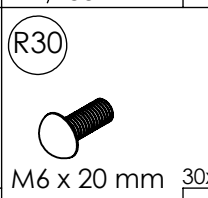
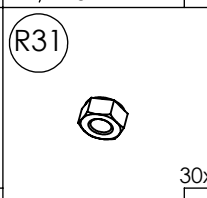
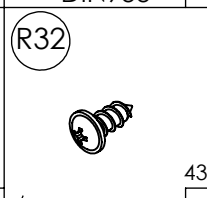
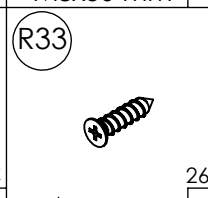
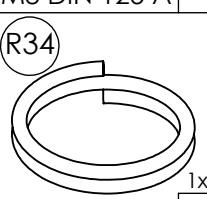
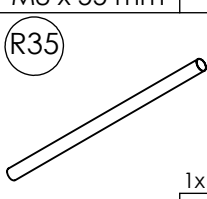
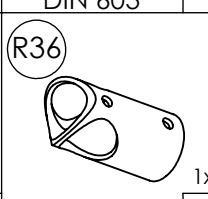
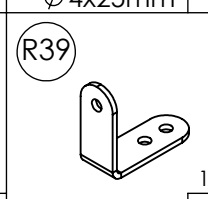
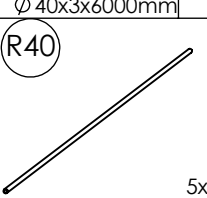
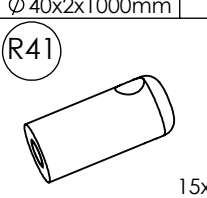
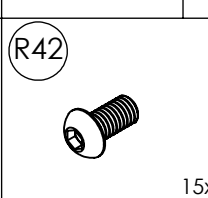
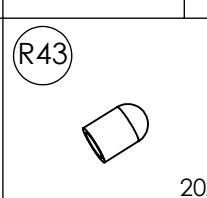
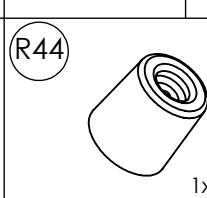
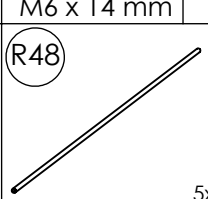
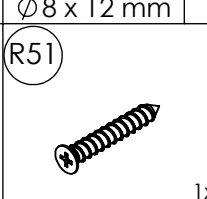
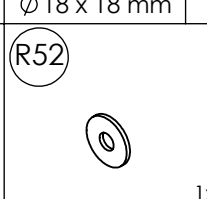
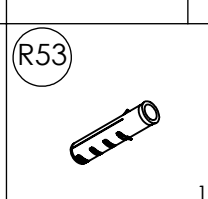
 <p>R01 12x</p>	 <p>R02 1x</p>	 <p>R03 13x Ø 108 x 210 mm</p>	 <p>R05 1x</p>	 <p>R06 26x Ø 115 x 3 mm</p>	 <p>R07 13x Ø 108 x 10 mm</p>
 <p>R08 13x Ø 108 x 5 mm</p>	 <p>R09 13x Ø 108 x 10 mm</p>	 <p>R10 1x Ø 50x1x992 mm</p>	 <p>R11 13x Ø 22x2x1250 mm</p>	 <p>R13 3x Ø 22x1x1000 mm</p>	 <p>R14 1x Ø 22x1x1045+140mm</p>
 <p>R16 30x</p>	 <p>R17 5x M20 x 1000 mm</p>	 <p>R18 5x M20 DIN 6334</p>	 <p>R19 2x</p>	 <p>R20 7x M20 DIN-EN 24035</p>	 <p>R21 1x M20 DIN 934</p>
 <p>R22 1x Ø 100 x 3 mm</p>	 <p>R23 17x Ø 22 mm</p>	 <p>R24 1x Ø 35 mm</p>	 <p>R25 4x Ø 40 mm</p>	 <p>R26 5x M8x70mm DIN933</p>	 <p>R27 4x M8x50 mm</p>
 <p>R28 5x M8 DIN 125 A</p>	 <p>R29 9x M8 x 55 mm</p>	 <p>R30 30x M6 x 20 mm DIN 603</p>	 <p>R31 30x M6 DIN 934</p>	 <p>R32 43x Ø 4,8 x 16 mm</p>	 <p>R33 26x Ø 4x25mm</p>
 <p>R34 1x Ø 40x3x6000mm</p>	 <p>R35 1x Ø 40x2x1000mm</p>	 <p>R36 1x</p>			 <p>R39 1x</p>
 <p>R40 5x Ø 6x1x6000 mm</p>	 <p>R41 15x</p>	 <p>R42 15x M6 x 14 mm</p>	 <p>R43 20x Ø 8 x 12 mm</p>	 <p>R44 1x Ø 18 x 18 mm</p>	
		 <p>R48 5x Ø 6x1x900 mm</p>	 <p>R51 1x Ø 4x50mm</p>	 <p>R52 1x M5 DIN 9021</p>	 <p>R53 1x Ø 6 mm</p>

S1

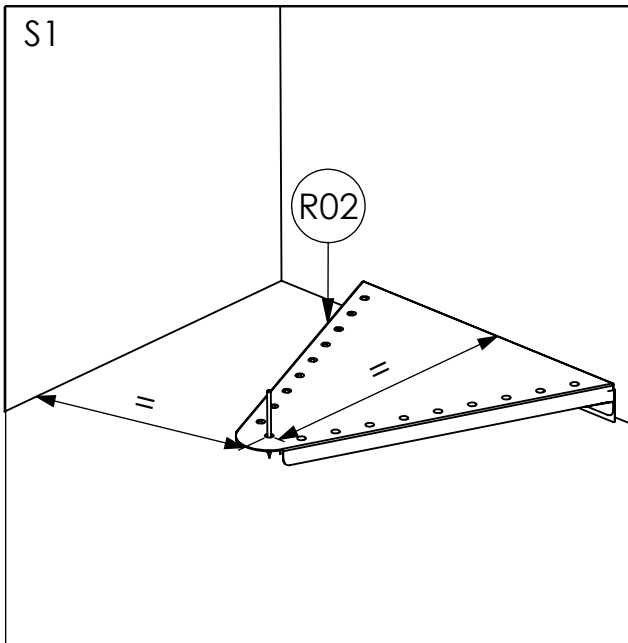

S2

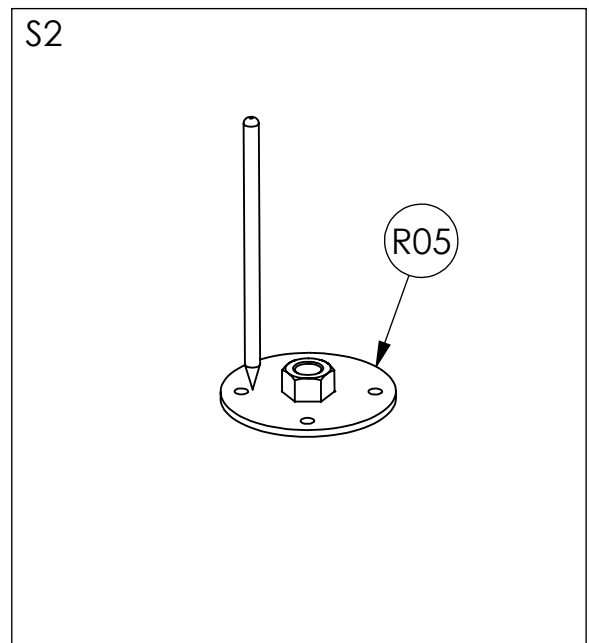

S3

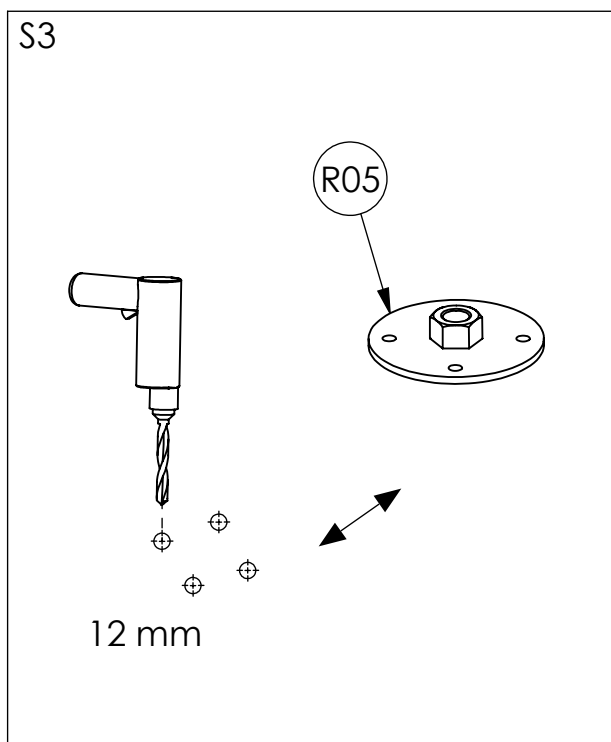

S4

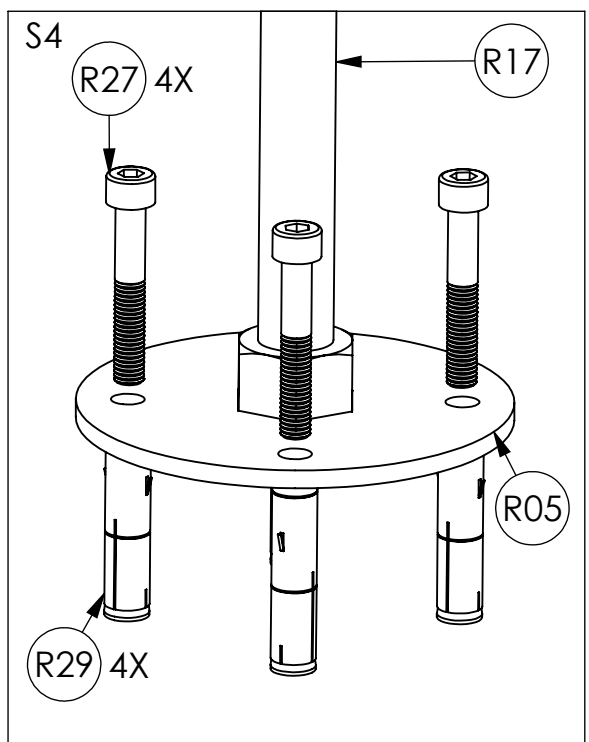

4

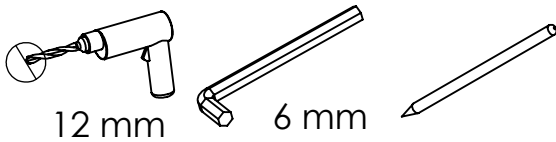

12 mm

6 mm

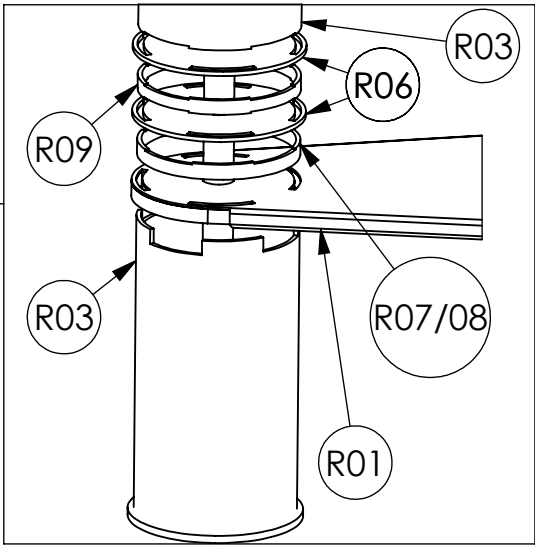
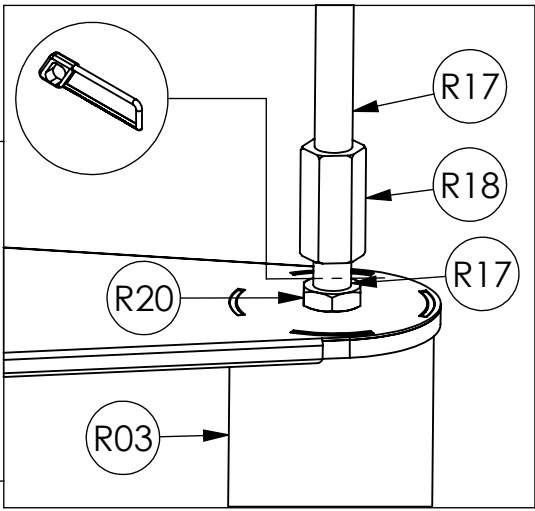
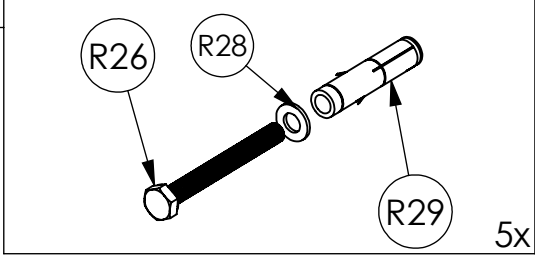
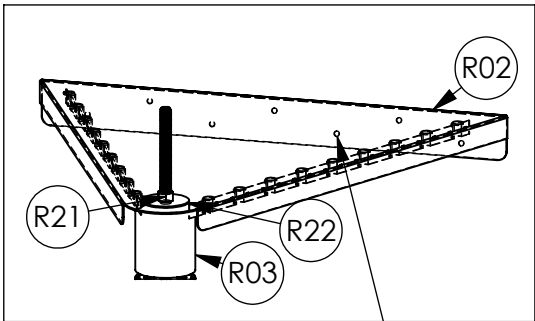
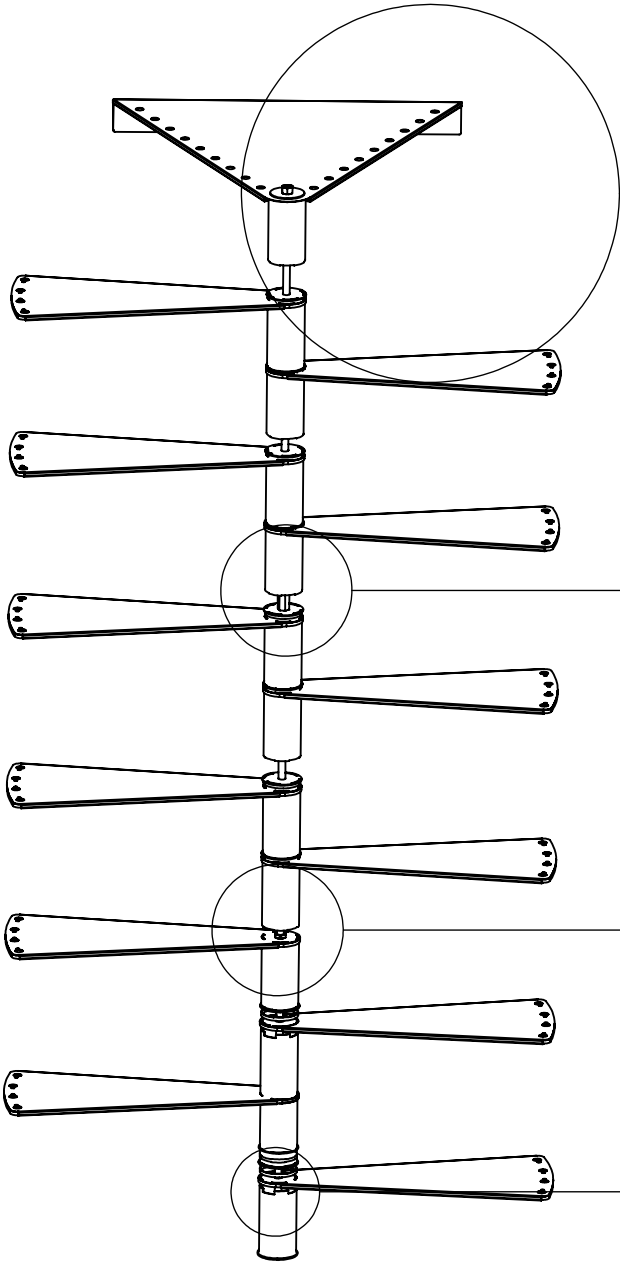

5

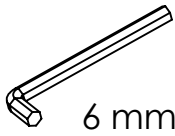

6 mm

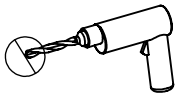

12 mm



30 mm



13 mm

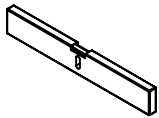

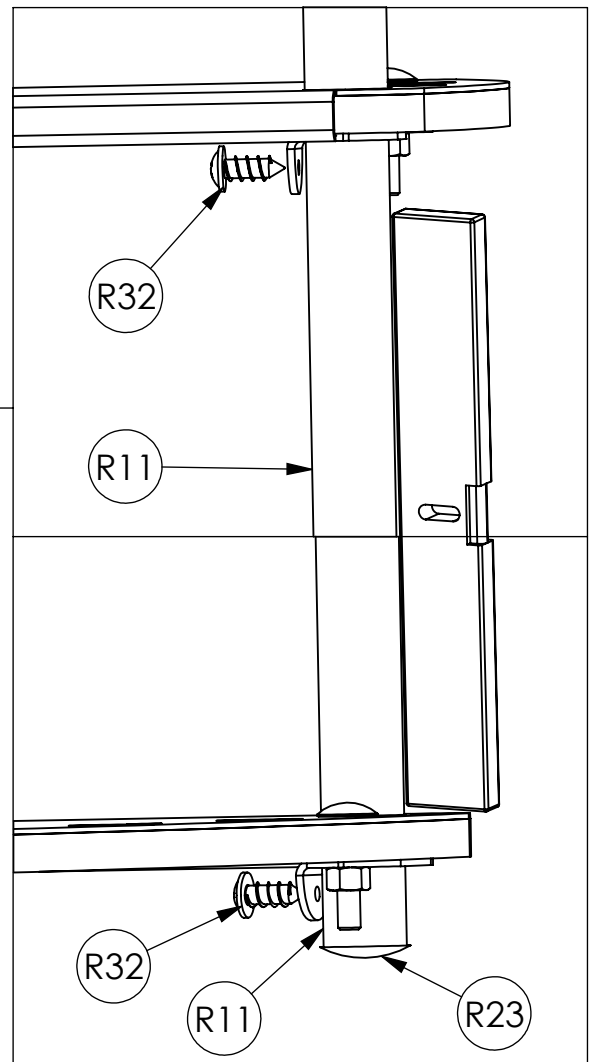
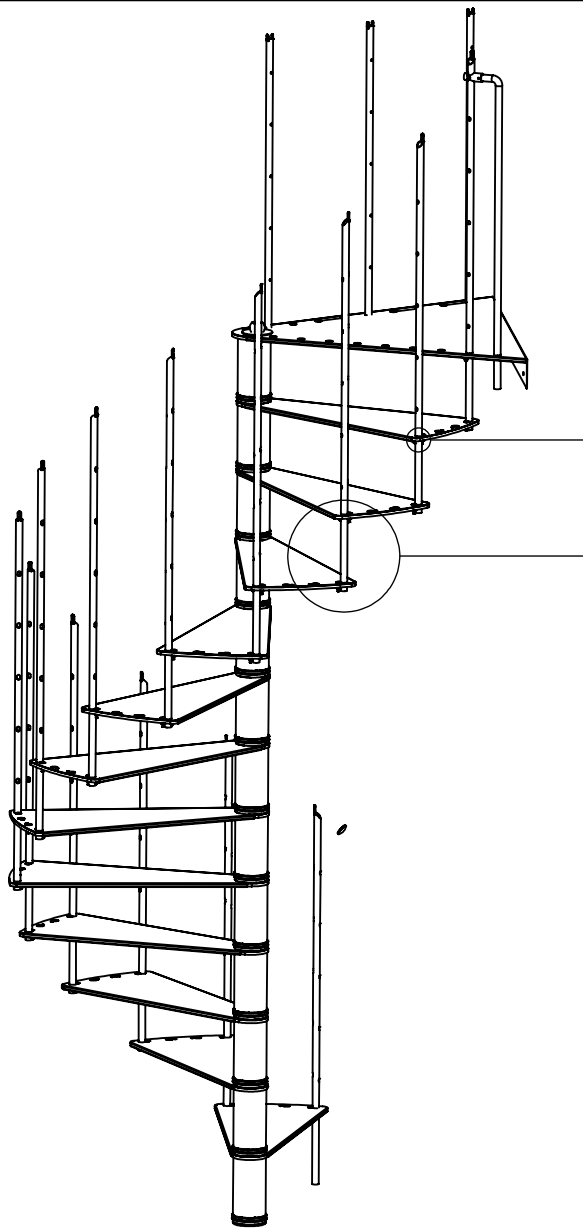
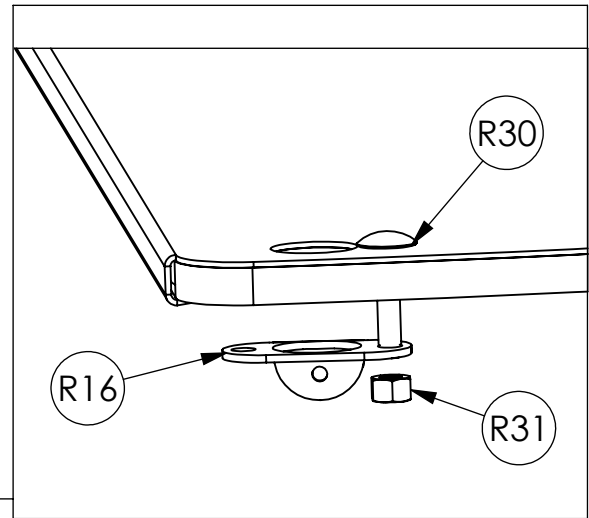
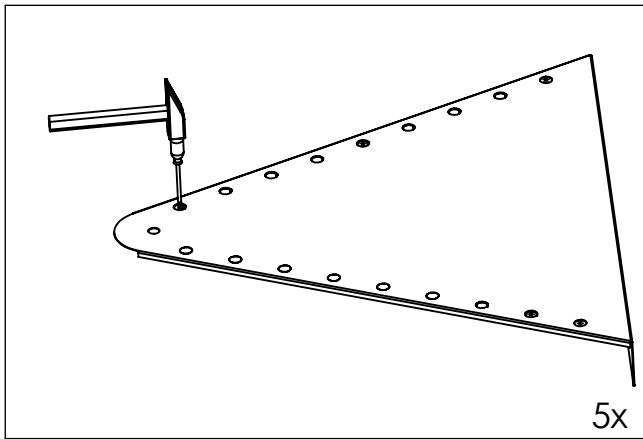

6

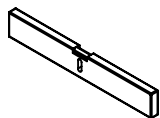
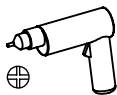

10 mm

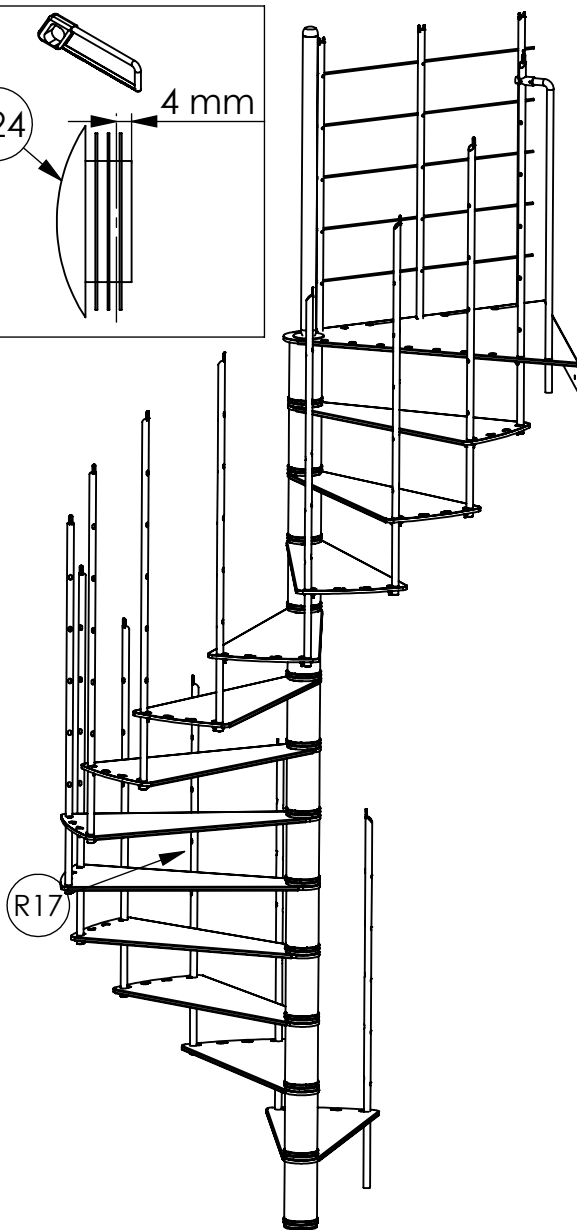
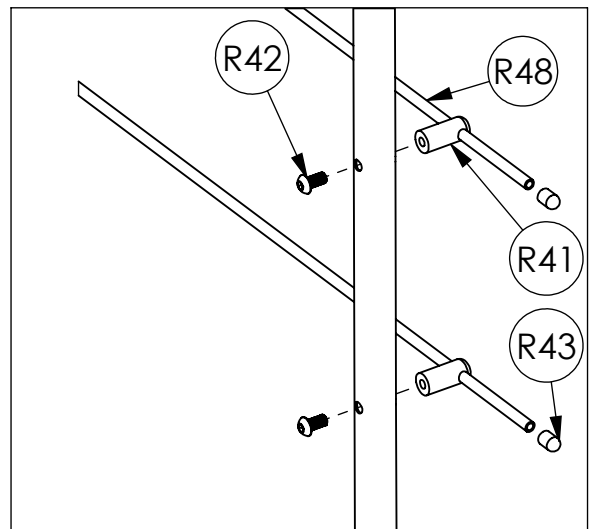
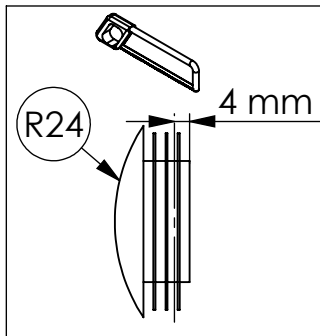
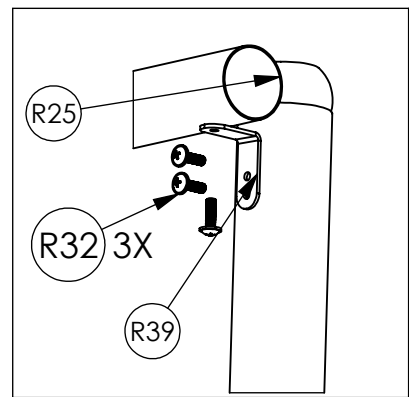
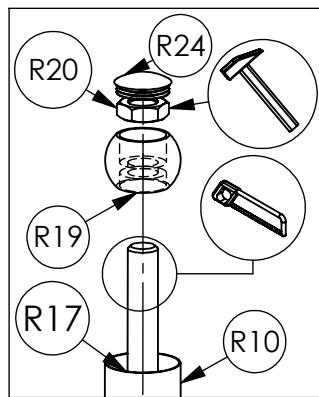
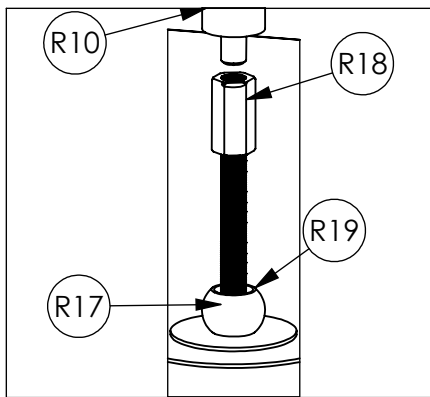

7

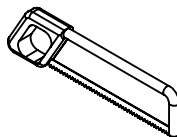
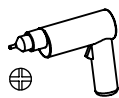
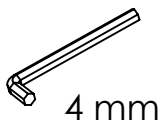

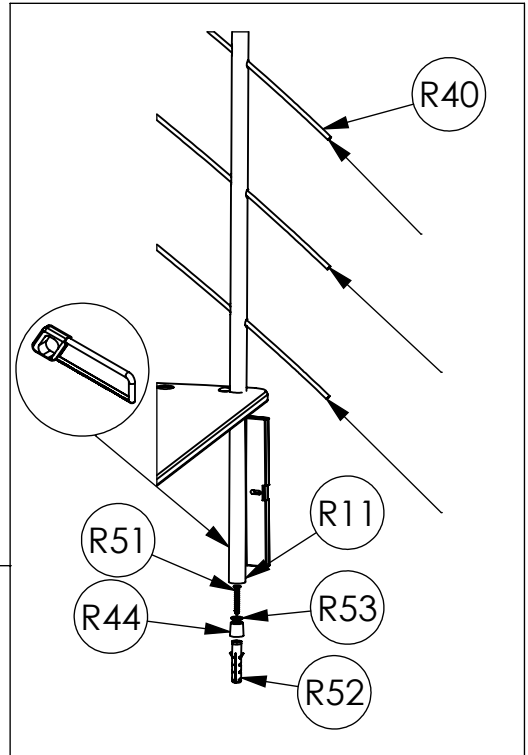
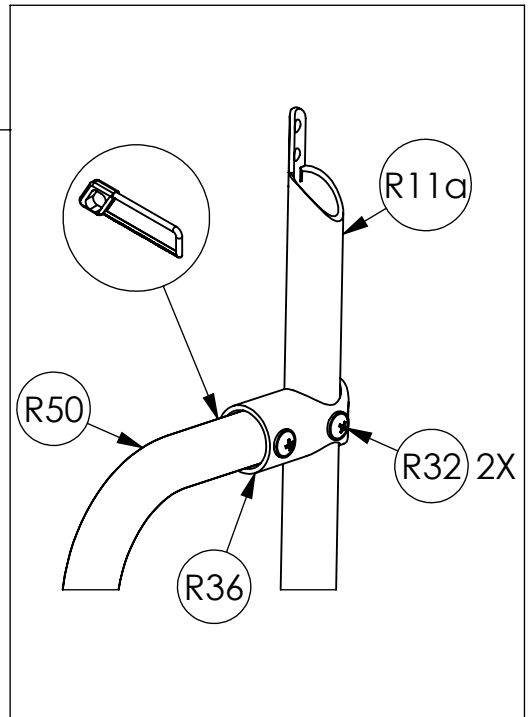
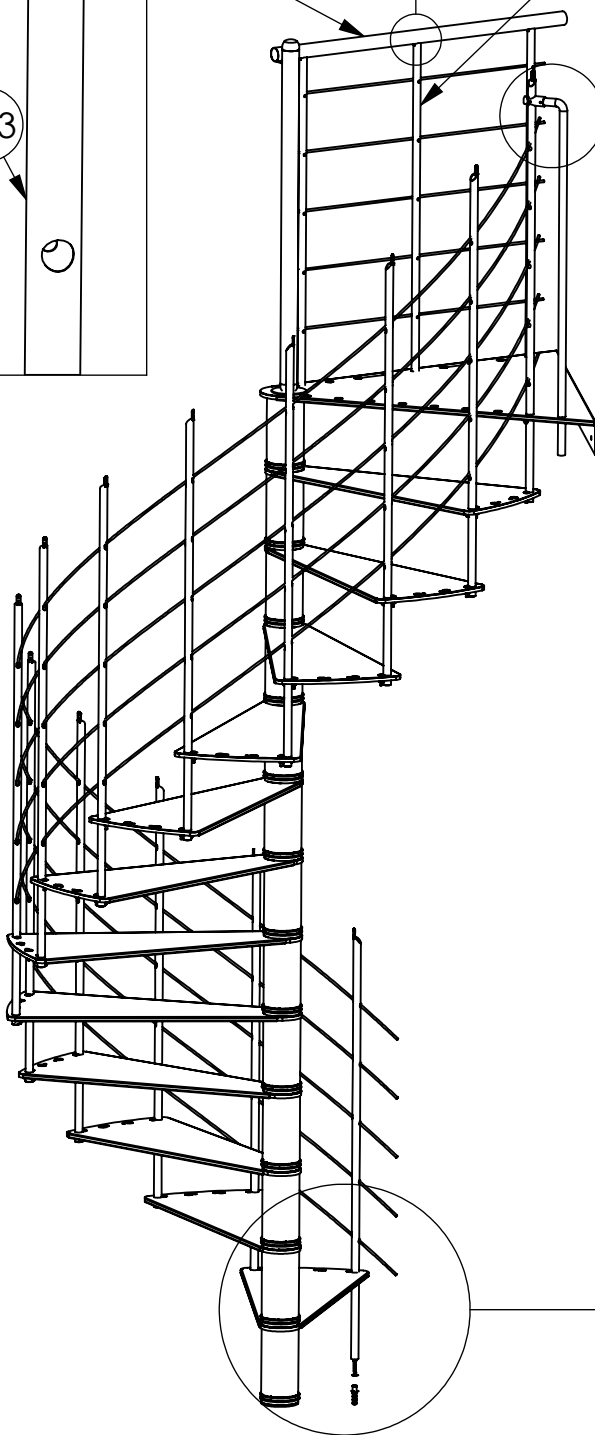
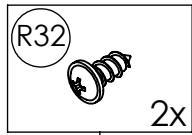
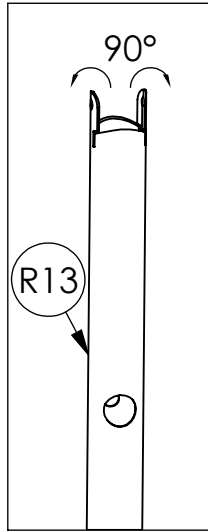

8

